



ULTRASILENT™

Acoustic Drainage Piping System
Technical Catalogue

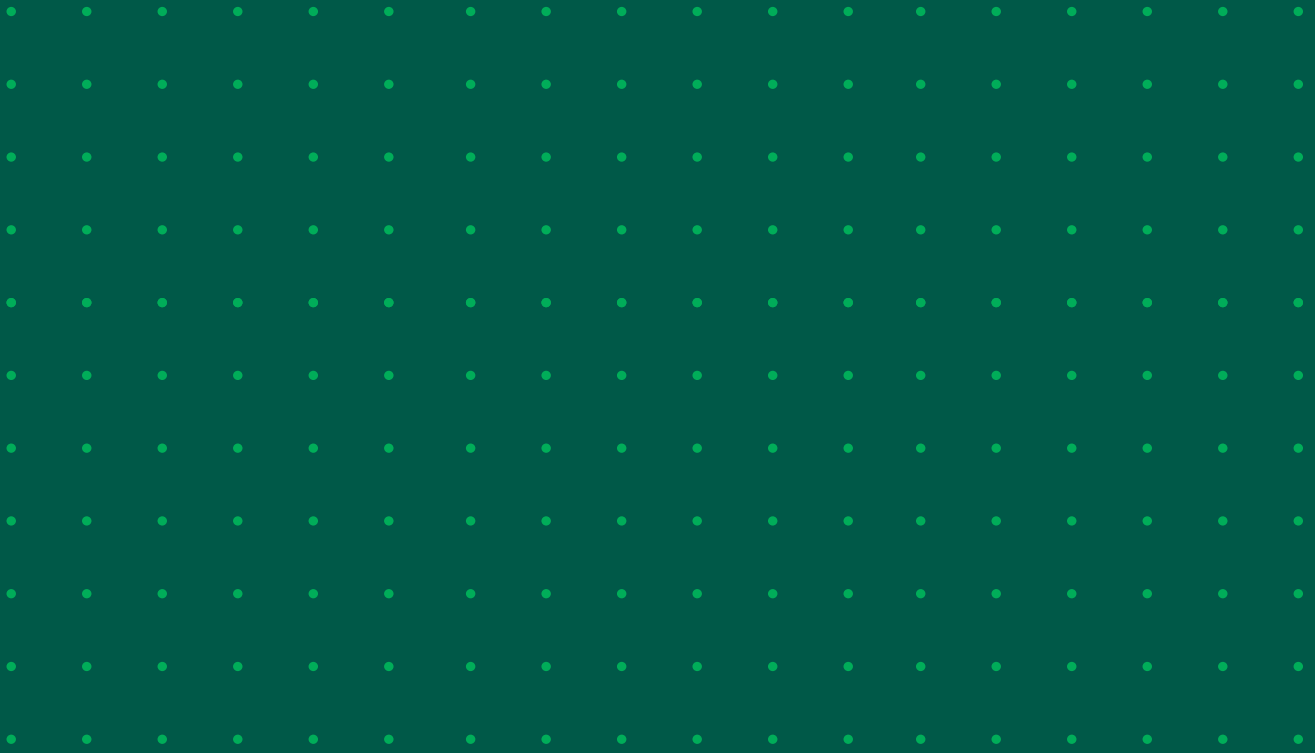

Table of Contents

Description of the Ultra Silent System	5
Main features	6
Marking	7
Datasheet	8
Acoustic Performance	9
Ultra Silent - Fraunhofer Test Report	9
Product Approvals and Certificates	10
Installation of the Ultra Silent System	11
1.1 Pipe preparation and assembly	11
1.2 Installation through ceilings, floors and walls	12
1.3 Repairs and installation	13
Transportation, handling and storage	13
Acoustic Clamp	14
Pressure Clamp, End Lock	15
Lock Seal	16
Ultra Seal	17
Product Range	18
Single Socket Pipe	19
Double Socket Pipe	20
Bend 15°, Bend 30°, Bend 45°	21
Bend 67.5°, Bend 87.5°	22
Branch 45°, Branch 87.5°	23
Swept Branch 87.5°, Corner Branch 87.5°, Double Branch 67.5°	24
Double Branch 87.5°, Inspection Pipe	25
Double Socket, Sleeve, Long Socket	26
Reducer, Technical Bend / Siphon Connector	27
Long Technical Bend / Siphon Connector, Straight Fitting / Siphon Connector, Rubber Gasket ..	28
End Cap, Long WC Bend	29
Acoustic Clamp, Lock Seal, End Lock	30
Pressure Clamp, Ultra Seal, Lubricant	31

Description of the

ULTRASILENT™ System

Acoustic triple layer, push-fit system made of pipes and fittings for soil and waste discharge, at low and high temperatures, both within the building structure (application area code B) as well as buried in the ground (application area BD).

Pipes have a three-layer wall structure with external and internal layers of polypropylene (PP) and a middle layer of mineral-filled polypropylene (PP-MD). Fittings are made of mineral filled Polypropylene (PP-MD). Materials are halogen and cadmium free.

Joints are made with push-fit sockets and elastomer seals.

Suitable for the drainage of fluids, in compliance with DIN 8078, with pH between 2 and 12 at atmospheric pressure and at maximum operating temperature between 95°C and 98°C for short periods.

Suitable for the construction of ventilation, rainwater and drainage systems. Can be used at environmental temperatures no lower than -25°C.

The system has a sound level $L_{sc,A}$ of 15dB(A) at a flow rate of 2 l/s, measured in compliance with EN 14366 and certified by the Fraunhofer Institut Für Bauphysik of Stuttgart number P-BA 20/2019e. The test was conducted using Huliot acoustic clamps.

Fire performance rating is D-s2,d2 in compliance with EN 13501-1.

The Ultra Silent System is certified by: SKZ, DiBt - Germany, DTI- Denmark, AENOR - Spain and SII - Israel. In compliance with HR 3.43, DIN EN 14366, UNE EN 1451-1, IS 958 Plastics piping system for soil and waste discharge (low and high temperature) within the building structure.



Main Features



Excellent acoustic performance

15dB(A) at a flow rate of 2 l/s, in compliance with EN 14366 using Huliote clamps



High impact resistance

even at low temperature (-25°)



Excellent resistance to high temperatures

95°C continuous, 98°C discontinuous



High chemical resistance



stable assembly

due to Increased depth of socket



smoother and increased flow

due to Branches with swept angle and optimized design



Wide range of diameters

DN 32mm to DN 200mm



High UV resistance

due to black color of external layer



Recyclability

Ultra Silent products have the Green Label mark for environmentally-friendly products



All materials comply with RoHS directive

and are Halogen and Cadmium free



10-year guarantee

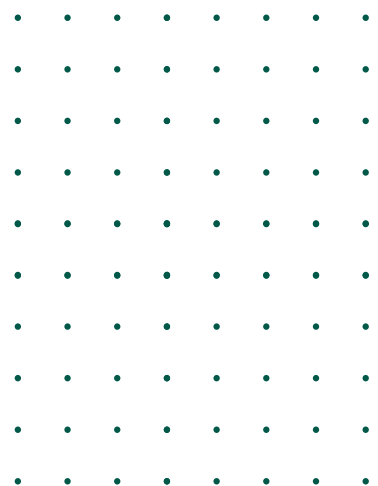

System marking

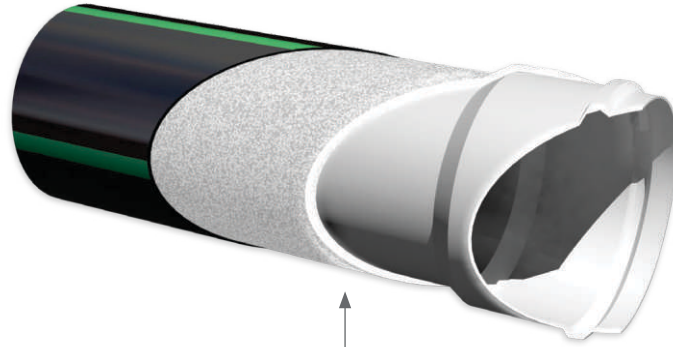

External Layer

Black PP provides excellent impact resistance and long-term UV protection.

Middle Layer

PP and PP-MD provide high mechanical resistance and excellent soundproofing performance.

Internal Layer

White PP provides the best flow performance and high-definition contrast for visual inspection.

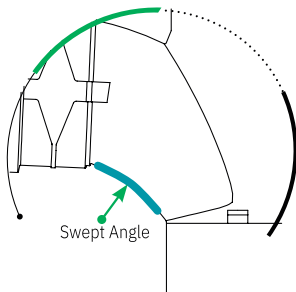

Clever Design

Ultra Discharge Rate
Ultra Smooth Flow

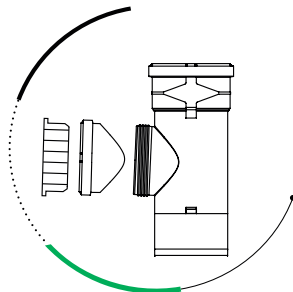

Internal Plug

Ultra Smooth Flow
Ultra Silent

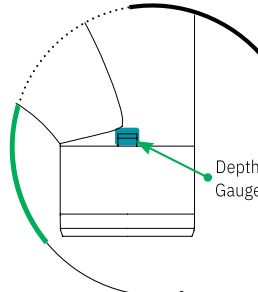

Depth Gauge

Ultra Fit

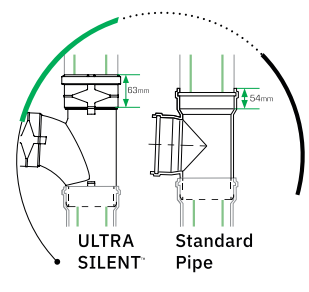

Extra Socket Depth

Ultra Stable
Ultra Solid



Marking

Marking of Pipes

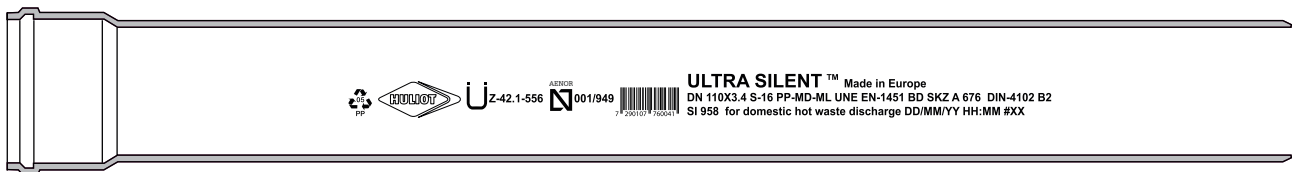

PP	Recyclable product
Huliot Logo	Manufacturer logo
dibt Z-42.1-556	DIBT approval
AENOR 001/949	AENOR product certificate
Barcode	Product barcode
Ultra Silent	System brand name
DN 110X3.4	Diameter and wall thickness
PP-MD-ML	Material
S-16	Pipe series
UNE EN-1451	Construction standard
BD	Application area
SKZ A 676	Certificate number
DIN 4102 B2	Fire resistance classification
SI 958	SI Standard
for domestic hot waste discharge	Pipe application
DD/MM/YY	Production date
HH:MM #XX	Production time and place

Marking of Pipes

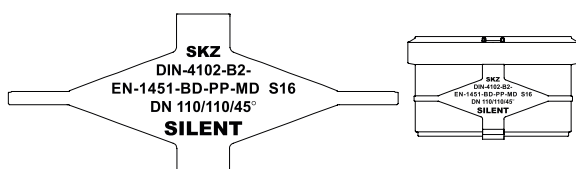

SKZ	Approval
DIN 4102 B2	Fire resistance classification
EN 1451 BD PP-MD S16	construction standard and application area, material, series
DN 110/110/87.5°	Type of product, diameters, angle
ULTRA SILENT	System brand name

Datasheet

Property	Value	Test Method
System Brand Name	Ultra Silent	
Application	Soil and waste discharge systems (low and high temperatures) within the building structure (application area code B) as well as buried in the ground (application area BD); construction of ventilation, rainwater and drainage systems inside the building structure (application area code "B")	
Pipe Material	Co-polymer PP for the external (black) and the internal (white) layers. Compound of PP and PP-MD for the middle (white) layer.	
Fitting Material	PP and PP-MD	
Connection	Push-fit sockets with elastomer rubber seals	
Seal Material	SBR-NR, NBR, EPDM	
Colour	Black	
Diameter	32-200 mm	
Density	Pipes: 1.15 ± 0.05g/cm ³ Fittings: 1.15-1.30g/cm ³	
Pipe Weight	Weight of 110 Pipe: 1.3 - 1.4 kg/m	
Elasticity Modulus	2.300 - 3.000 N/mm ²	ISO 178
Elongation	0.09 mm/m C°	Raw Material Properties
Ring Stiffness	SN6> (6.0 kN/m ²)	ISO 9969
Halogen & Cadmium Content	Free of halogen or cadmium	
Chemical Resistance	Discharge media between pH 2 and pH 12	DIN 8078
Minimum Working Temperature	-25°C	
Waste Water Temp. (Max.)	+95° (continuous) +98° (discontinuous)	
Fire Resistance	D-s2, d2 B2	EN 13501-1 DIN 4102-1
UV Resistance	Suitable for external installation when protected from exposure to direct sunlight (for instance, by means of special UV protective coating); can be stored outside up to two years	
Acoustic Performance	Lsc,A = 15 dB(A) at 2l/s, measured at ground level behind installation wall, with two Huliot acoustic clamps per floor	EN 14366
Construction Standard	HR 3.43, DIN EN 14366, UNE EN 1451-1, IS 958	

Acoustic Performance

Ultra Silent Sound Pressure Levels $L_{SC,A}$ EN 14366

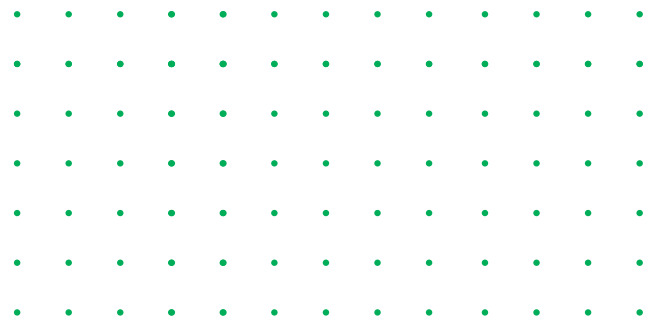
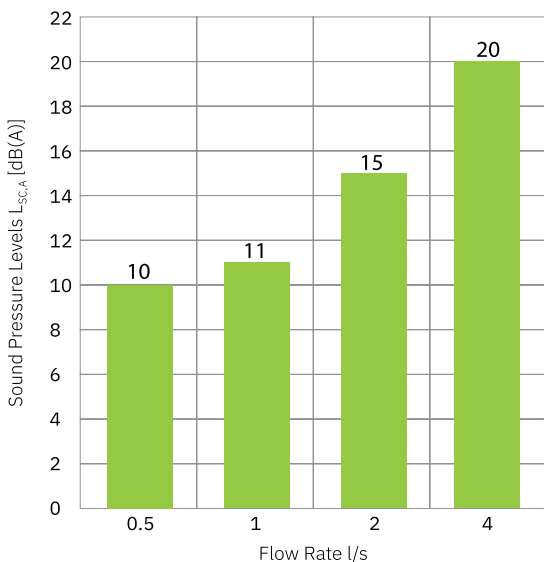

Sound level diagram resulting from Fraunhofer Test P-BA 20/2019e, according to EN 14366. The test was conducted using Huliote acoustic clamp.

Ultra Silent - Fraunhofer Test Report

Fraunhofer
IBP

Institution for testing, supervision and certification, officially recognized by the building supervisory authority. Approvals of new building materials, components and types of construction.

Director: Prof. Dr. Philip Leistner
Prof. Dr. Klaus Peter Seibauer

Test Report P-BA 20/2019e

Determination of the Acoustic Performance of a Wastewater Installation System in the Laboratory according to EN 14366

Client: HULIOT (A.C.S) LTD, Kibbutz Sde Nehemia, D.N. Gallil Elyon 12145, ISRAEL

Test object: Wastewater system "ULTRA SILENT, DN 110x3.4, PP ML MD - 516, 16/11/18" (manufacturer: HULIOT (A.C.S) LTD.). The wastewater system consisted of straight plastic pipes and fittings "ULTRA SILENT, PP-MD 516" and pipe clamps with elastic inlay "Huliot 107-113, new inlay" (manufacturer: HULIOT (A.C.S) LTD.), mounted as sliding and fixing clamps.

Content:

Results sheet 1:	Summary of test results
Figures 1 to 3:	Detailed results
Figures 4 and 5:	Test set-up
Annex A:	Measurement set-up, noise excitation, acoustic parameters
Annex F:	Evaluation of measurements
Annex P:	Description of the test facility
Annex V:	Assessment according to VDI 4100

Test data: The measurement was carried out on February 12, 2019 in the test facilities of the Fraunhofer Institute for Building Physics in Stuttgart.

Stuttgart, April 15, 2019

Responsible Test Engineer: Head of Laboratory:

Dipl.-Ing. (FH) J. Mohr, M.B.B. Dipl.-Ing. (FH) S. Ohler

The test was carried out in a laboratory, accredited according to DIN EN ISO/IEC 17025:2005 by DAkkS. The accreditation certificate is D-PL-11140-11-01.

Any publication of this document in part is subject to written permission by the Fraunhofer Institute for Building Physics (IBP).

Fraunhofer-Institut für Bauphysik - Prüflabor Bauakustik und Schallimmissionschutz
Heidelstraße 12, D-70569 Stuttgart
Telefon +49(0) 71 1970-3314, Fax -3406
ibp@ibp.fraunhofer.de
www.prueflaefen.fraunhofer.de/de/ak/kred/leiste-prueflaefen.html

Determination of the Acoustic Performance of a Wastewater Installation System in the Laboratory according to EN 14366 P-BA 20/2019e
Results sheet 1

Client: HULIOT (A.C.S) LTD., Kibbutz Sde Nehemia, D.N. Gallil Elyon 12145, ISRAEL

Test specimen: Wastewater system "ULTRA SILENT, DN 110x3.4, PP ML MD - 516, 16/11/18" (manufacturer: HULIOT (A.C.S) LTD.). The wastewater system consisted of straight plastic pipes and fittings "ULTRA SILENT, PP-MD 516" and pipe clamps with elastic inlay "Huliot 107-113, new inlay" (manufacturer: HULIOT (A.C.S) LTD.), mounted as sliding and fixing clamps. Test object no.: 11359-01; see figure 4 and 5.

Test set-up:

- The pipe system was mounted according to figure 4 (see also Annex A).
- The system consisted of wastewater pipes (nominal size OD 110), three inlet tees (curved, 88°), two 45°-basement bends and a horizontal drain section. The inlet tees in the basement and in the ground floor were closed by lids supplied by the manufacturer.
- Pipe system: "ULTRA SILENT, DN 110x3.4, PP ML MD - 516, 16/11/18": Three-layer pipes: Material PP ML MD. Wall thickness 3.4 mm, weight 1.32 kg/m, density 1.15 g/cm³, values measured by IBP. One-layer fittings: Material PP-MD, wall thickness 3.6 mm, density 1.24 g/cm³, values measured by IBP. Plug connection of the pipes and fittings (shaped pipe sockets).
- Pipe clamps: Steel pipe clamp with new elastomer inlay and with one-sided closure, "HULIOT 107-113" (manufacturer: HULIOT), mounted as sliding and fixing clamps. In every storey (EG and UG) two pipe clamps were installed. In the upper wall area one clamp was mounted as a sliding clamp with 2 black spacers (15 mm) on one side of the clamp. In the lower wall area one clamp was mounted as a fixing clamp with 1 yellow spacer (5 mm) on one side of the clamp. The clamps were fixed to the installation wall with dowels and thread rods (figure 5).

The wastewater installation system was mounted by a technician under the authority of Fraunhofer IBP.

Test facility: Installation test facility P12, mass per unit area of the installation wall: 220 kg/m², mass per unit area of the ceiling: 440 kg/m². Installation rooms: sub-basement (KG), basement (UG) front, ground floor (EG) front and top floor (DG), measuring rooms: UG front, UG rear (details in Annex P and EN 14366: 2005-02).

Test method: The measurements were performed according to EN 14366:2005-02; noise excitation by steady water flow with 0.5 l/s, 1.0 l/s, 2.0 l/s and 4.0 l/s. Additional evaluation for comparison with requirements following German standards DIN 4109:2018-01 and VDI 4100:2012-10 (details in Annexes A, F and V).

Result:

Wastewater system "ULTRA SILENT, DN 110x3.4, PP ML MD - 516, 16/11/18" (manufacturer: HULIOT (A.C.S) LTD.). The wastewater system consisted of straight plastic pipes and fittings "ULTRA SILENT, PP-MD 516" and pipe clamps with elastic inlay "Huliot 107-113, new inlay" (manufacturer: HULIOT (A.C.S) LTD.), mounted as sliding and fixing clamps.	Flow rate [l/s]				
	0.5	1.0	2.0	4.0	
Airborne sound pressure level L_{A} [dB(A)]					
Structure-borne sound characteristic level L_{SC} [dB(A)] according to EN 14366 for the basement test-room	UG front	43	49	52	54
Structure-borne sound characteristic level L_{SC} [dB(A)] according to EN 14366 for the basement test-room	UG rear	<10	11	15	20
Installation sound level $L_{Aeq,T}$ [dB(A)] following DIN 4109 in the basement test-room	UG front	43	49	52	54
Installation sound level $L_{Aeq,T}$ [dB(A)] following DIN 4109 in the basement test-room	UG rear	<10	15	19	24
Installation sound level $L_{Aeq,T}$ [dB(A)] following VDI 4100 in the basement test-room	UG front	40	47	49	52
Installation sound level $L_{Aeq,T}$ [dB(A)] following VDI 4100 in the basement test-room	UG rear	<10	12	16	21

Test date: February 12, 2019

Notes:

- For comparing test results with requirements, note Annex A.
- Sound levels below 10 dB(A) are not measured by the global test report, since they are subject to an increased measurement uncertainty and moreover are not noticeable in a normal living environment.

The test was carried out in a laboratory, accredited according to DIN EN ISO/IEC 17025:2005 by DAkkS. The accreditation certificate is D-PL-11140-11-01.

Stuttgart, April 15, 2019
Head of Laboratory:

Product Approvals and Certificates

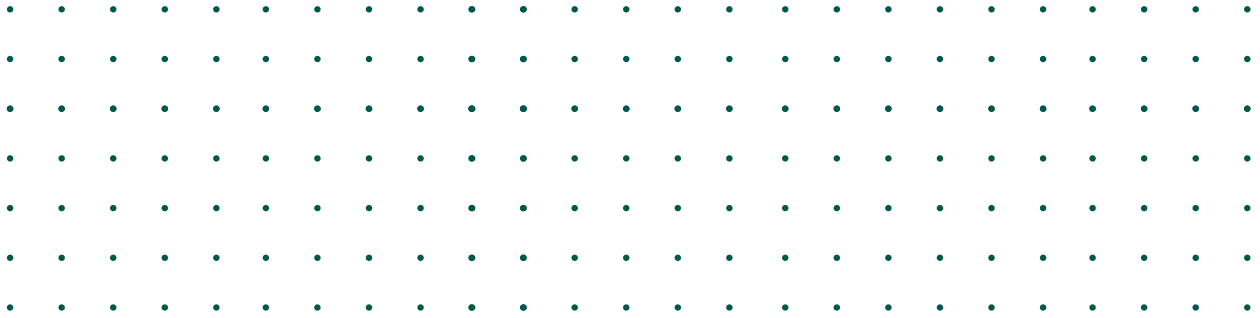

Deutsches
Institut
für
Bautechnik



ZERTIFIKAT **SKZ**

Certificate

SKZ - Testing GmbH awards the following company

HULIOT A.C.S. Ltd.
Kibbutz Sde Nehemia
12145 D.N. GALIL ELYON
ISRAEL

Production site: HULIOT A.C.S. Ltd., IL-12145 D.N. GALIL ELYON

the right to use the SKZ testing and inspection mark



A 624

for the following plastic products

Waste water pipes made of polypropylene PP/PP-MD/PP and fittings made of polypropylene PP-MD within the building structure, group 1 and 2

Trade name: ULTRA SILENT

SKZ Specification for Tests and Inspection **HR 3.43**

Users of the SKZ mark are obliged to observe the required regulations for the production and testing of these products.

Date of initial certification: 20 February 2015

Date of expiry: 13 December 2022



Würzburg, 14 December 2017

The original language of this certificate is German. In case of doubt, the German version is obligatory.

Hans-Peter Krause
Dipl.-Ing. Hans-Peter Krause
Certification body

ZERTIFIKAT **SKZ**

SKZ - Testing GmbH awards the following company

HULIOT D.O.O.
Vrhniška cesta 30
1354 HORJUL
SLOVENIA

Production site: HULIOT D.O.O., SL-1354 HORJUL

the right to use the SKZ testing and inspection mark



A 676

for the following plastic products

Waste water pipes made of PP with mineral filling within the building structure, group 1 and 2

Trade name: ULTRA SILENT

SKZ specification for tests and inspection **HR 3.43:2016-11**

Users of the SKZ mark are obliged to observe the required regulations for the production and testing of these products.

Date of initial certification: 28 April 2015

Date of expiry: 27 April 2025

Würzburg, 28 April 2020



Hans-Peter Krause
Dipl.-Ing. Hans-Peter Krause
Head of Certification Body

The original language of this certificate is German. In case of doubt, the German version is obligatory.
SKZ - Testing GmbH, Friedrich-Berglun-Ring 22, 87076 Würzburg, Germany, Tel. +49 931 4104-0, testing@skz.de, www.skz.de



Allgemeine
bauaufsichtliche
Zulassung

Zulassungsnummer:
Z-42.1-556

Antragsteller:
Huliot A.C.S. Ltd.
Kibbutz Sde Nehemia
1214500 UPPER GALILEE
ISRAEL

Zulassungsgegenstand:
Rohre und Formstücke aus PP-MD für Abwasserleitungen innerhalb der Gebäudestruktur mit der Bezeichnung "Ultra Silent"

Der oben genannte Zulassungsgegenstand wird hiermit allgemein bauaufsichtlich zugelassen. Dieser Bescheid umfasst acht Seiten und zwölf Anlagen. Diese allgemeine bauaufsichtliche Zulassung ersetzt die allgemeine bauaufsichtliche Zulassung Nr. Z-42.1-556 vom 14. Oktober 2017.

Deutsches Institut für Bautechnik

Zulassungsstelle für Bauprodukte und Bauarten
Bautechnisches Prüfamt
Eine vom Bund und den Ländern
gemeinsam getragene Anstalt des öffentlichen Rechts
Mitglied der EOTA, der UEAtc und der WFTAD

Datum: 20.09.2018
Geschäftszeichen: III 55-1.42.1-22/18

Geltungsdauer
vom: 20. September 2018
bis: 17. Oktober 2022

DIBt | Kolonnenstraße 30 B | D-10829 Berlin | Tel.: +49 30 78730-0 | Fax: +49 30 78730-330 | E-Mail: dibt@ditb.de | www.dibt.de

IBS - INSTITUT FÜR

BRANDSCHUTZTECHNIK UND SICHERHEITSFORSCHUNG
 GESELLSCHAFT M. B. H.
AKKREDITIERTE PRÜF- UND INSPEKTIONSSTELLE

ZENTRALE A 4617 LINZ, PETZOLDSTRASSE 45 46, POSTFACH 22, TELEFON 0327611 956, FAX 0327611 95
 ZWEIGSTELLEN A 100 WIEN FLUGHAFEN SPITZE PARK 1, TOP FLD, TELEFON 01210720, A 8020 SALZBURG, GARDNERPLATZ 10, TELEFON 066264022
 A 9100 VOLKSEMARKT, GRIFFRERSTRASSE 5, TELEFON 032323200, A 6020 INNSBRUCK, URBANERWEG 18, TELEFON 031238020
 A 6300 BREGENZ, ADLMEISTER 12, TELEFON 0907 47878
 www.ibs-austria.at - 03168@ibs-austria.at - 03161 9669950 - Fax 0316 878154 - REGISTERNUMMER: LINZ, UID-NR. ATU 12238 965

Classification of Reaction
 to Fire Performance

Report on classification of the burning behaviour of the building product
 "Huliot Ultra Silent"

Report no.: 12112803A
 Date: 27.05.2013
 Official in charge: H. Aglas/ko
 DD: 818

Applicant/manufacture: Huliot
Kibbutz Sde Nehemia
IL-12145 D.N. Galil Elyon

Date of application: 01.02.2013

Specimen of classification: Plastic piping system "Huliot Ultra Silent"

Short evaluation: In accordance with EN 13501-1:2009 the above mentioned building product is ranked into the European Class D – s2, d2 because of its fire behaviour. The classification of reaction to fire and the therefore valid practical range of application is obvious by the representational classification report.

This report contains: 5 text pages

The duplication of this classification report in extracts is only allowed with written authorisation from the IBS

Installation of the ULTRASILENT™ System

1.1 | Pipe preparation and assembly

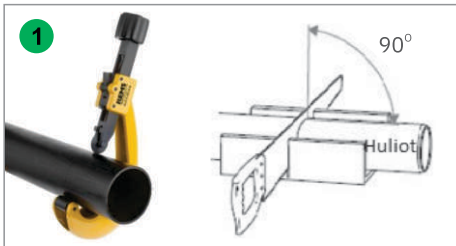

Cut the Huliot pipe using a suitable pipe cutter available in market or a fine tooth saw that is suitably guided to guarantee a perpendicular cut.

Chamfering and beveling the Huliot pipe ends to an angle of roughly 15o to 30o using a suitable chamfering tool or a fine file. The chamfered surface must be smooth to avoid damaging the ring seal inside the socket when the pipe is inserted.

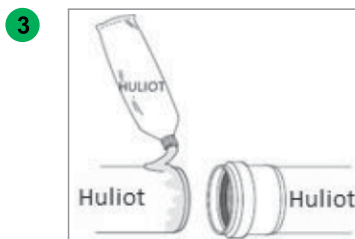

Ensure that the inside of the socket, the seal and the spigot end of the pipe piece to be inserted are perfectly clean. Lubricate the spigot/pipe/fitting end and rubbering with the appropriate Huliot lubricant only.

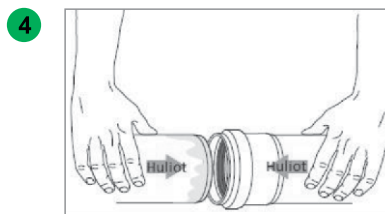

Join the pipes and fittings or fittings to fittings together by inserting the end/spigot into the socket to maximum socket depth.

Hanging distances

Pipe DN (External diameter)	Max. bracket distance for Horizontal installation - D1 max	Max. bracket distance for Vertical installation - D max
Ø 40	0.8	1.0
Ø 50	0.8	1.0
Ø 75	0.8	1.1
Ø 90	0.9	1.4
Ø 110	1.1	1.5
Ø 125	1.1	1.5
Ø 160	1.5	1.5
Ø 200	1.5	1.5

Pipe DN (External diameter)	Hanging distance from the ceiling (X)	Ceiling Rod diameter
110, 125, 160, 200	Up to 0.7 meters	3/8"
	Over 0.7 meters Up to 2.5 meters	1/2"
	Over 2.5 meters	3/4"

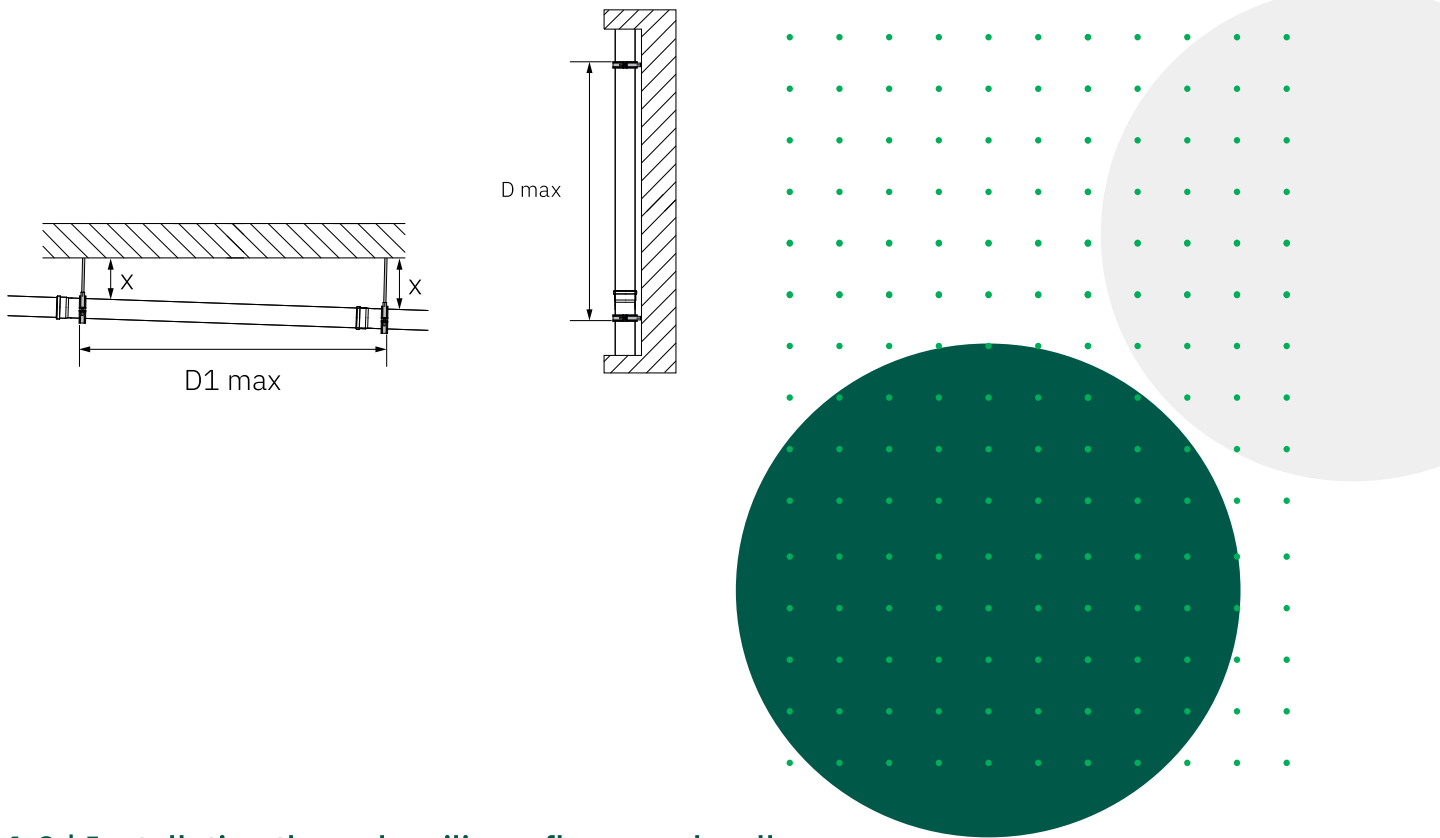

1.2 | Installation through ceilings, floors and walls

It is important in acoustic insulated systems to avoid contact between system components and rigid elements, such as walls, ceilings, floors etc., in order to prevent structure-borne noise transmission.

For pipes traversing walls and ceilings, a space of at least 30 mm should be maintained between the pipe and any rigid material.

If the spaces around the pipes traversing walls and floors must be filled, use only soft construction materials such as foam or glass fiber (Figure 1).

In case of pipes traversing floors where protection against humidity is needed we recommend to use Huliot Ultraseal (see description in following pages).

For improved hydraulic flow and reduced noise, 87° bends are not recommended to be used for changing flow direction from vertical to horizontal. It is preferable to use two 45° bends, with 2D minimum length of connecting pipe between them (Figure 2).

When installing pipes in open spaces (such as basements, parking garages etc.), above suspended ceilings or behind screen walls, prevent any contact of other material (such as suspended ceiling, electrical, water, ventilation and air conditioning systems etc.) with the pipes (Figure 3).

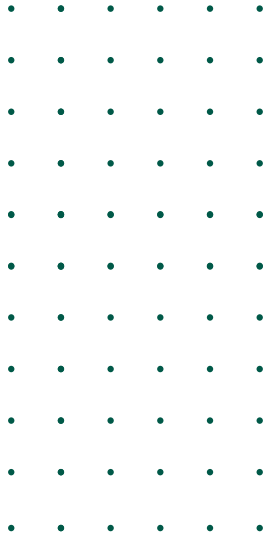
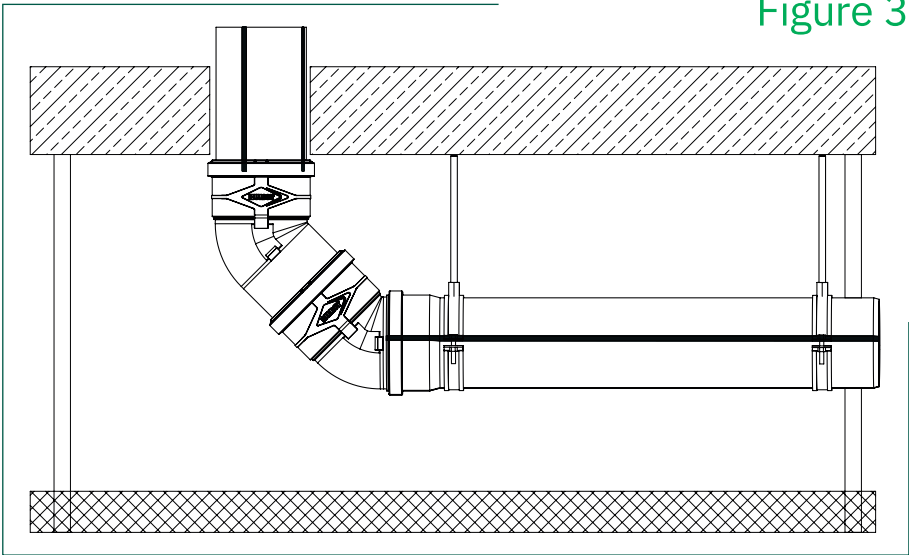
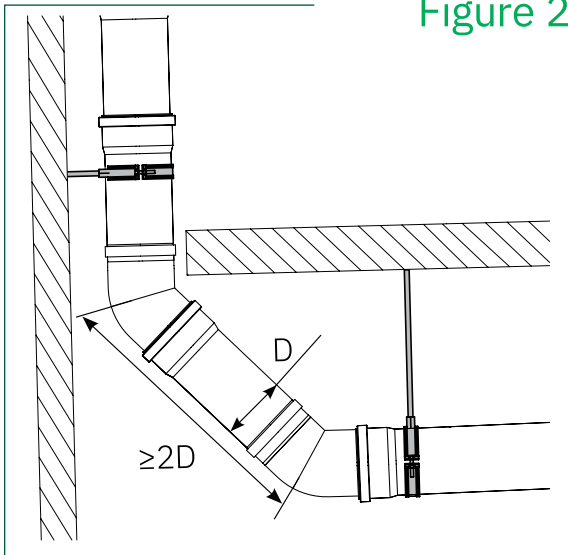
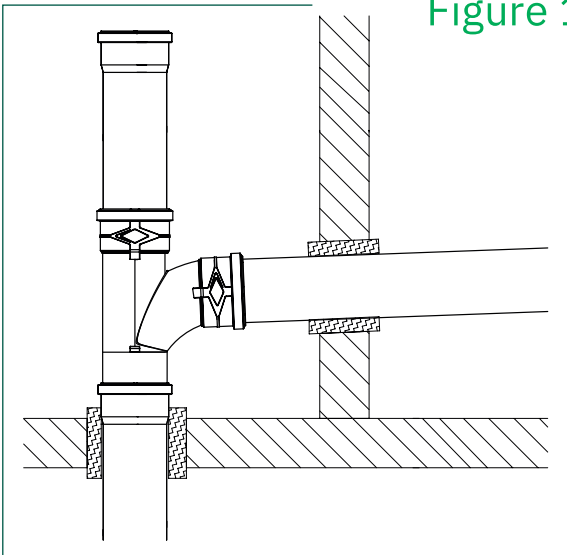
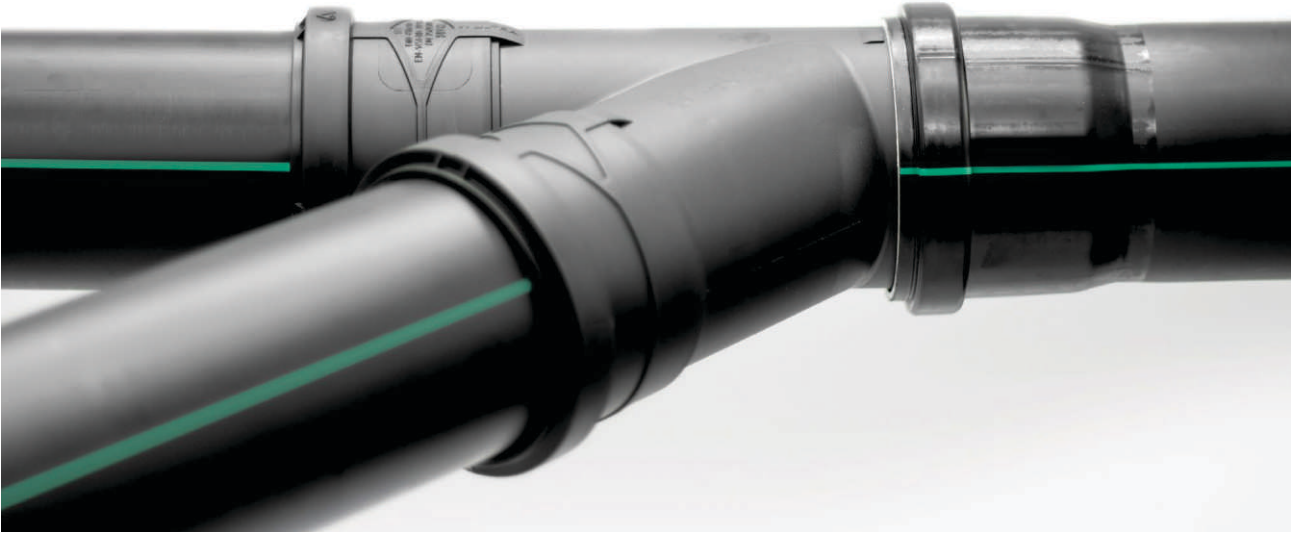



1.3 | Repairs and installation

To add a branch (USEA) to an existing pipe with long socket (USTL) and sleeve (USU), insert the long socket plain end into the branch socket, cut the equivalent of the socket length from the existing pipe piece. Insert the long socket into the upper pipe all the way. Fix the sleeve on the lower pipe and slide the branch and long socket down into the sleeve (Figure 4). An alternative possibility is to use two sleeves and plain pipe (the minimum plain pipe length must be more than double that of the external pipe diameter DN, as in Figure 5).

To fix punctured or damaged pipe, the same methods can apply with one socket pipe (USEM) instead of the branch and for adding inspection pipe (USRE) or double branch (USDA).

Figure 4

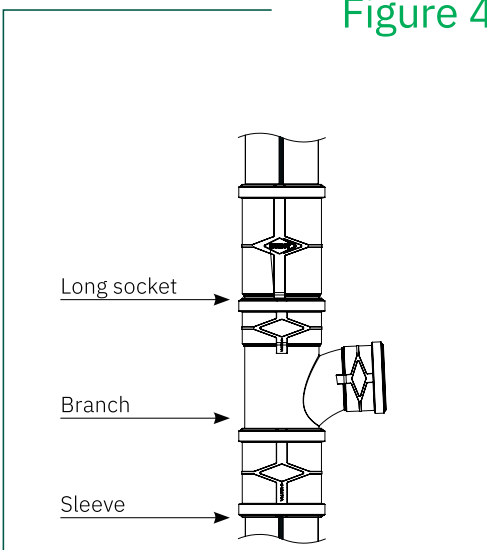
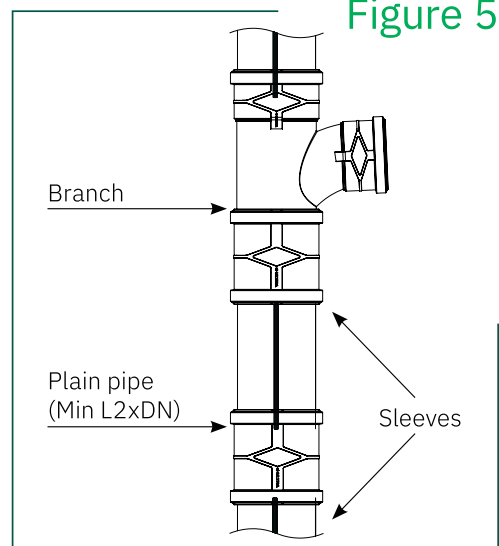
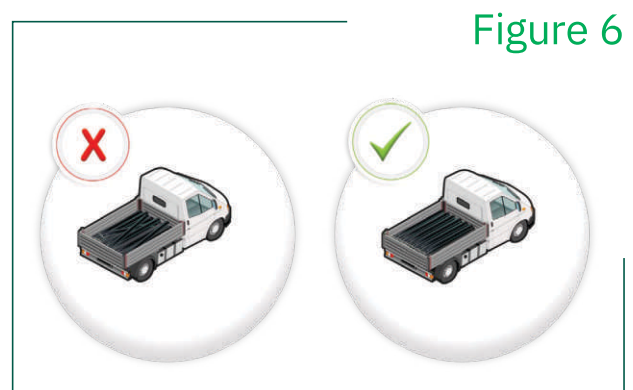
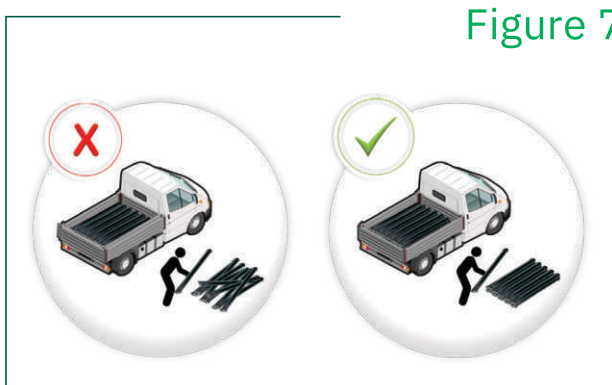

Figure 5



Transportation, Handling and Storage



It is recommended to handle the pipes and fittings in their original sales packaging to protect them and prevent damage during loading and transporting.

Load and transport pipes in straight, horizontal position with the full length supported (note that the sockets are unencumbered all around), avoid extreme pressure on the pipes (straps or other heavy materials).

Unload and handle pipes carefully and lay them in a straight, horizontal position (pay attention to positioning of the sockets), on a smooth surface (Figure 6, Figure 7).

Some sizes of pipes and all fittings are packed in carton boxes. Protect them from rain and moisture and store them in a dry place. It is recommended to store the pipes and fittings in their original sales packaging to protect them from damages.

Ultra Silent pipes are UV protected and can be stored outdoor for up to 2 years (depending on geographical location). The gasket material can withstand outdoor storage for up to 2 years and after this period must be replaced before installing. When using mechanical tools and machines (forklifts, cranes etc.) extra caution should be taken to prevent damages to the products.

Optical defects (external scratches and pigment changes etc.) have no influence on the quality and/or functionality of the system.

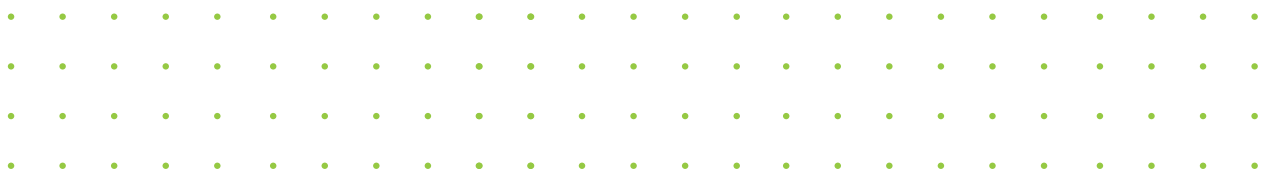



ACOUSTIC CLAMP™

New! Huliot Acoustic Clamp for perfect Ultra Silent installation

Structured rubber profile with hollow sections for maximal pipe grip and minimal vibration intensity passed to the constructive elements

Easy and simple clamp fastening by a single screw on only one side

EPDM rubber body with air ducts for vibration prevention

Rubber softness level: 25 ± 5 shore

Acoustic Clamp Assembly instructions

Use Huliot acoustic clamps or equivalent products only

It is advisable to install the clamps on external walls only. Installation on interior walls will adversely affect acoustic performance

It is recommended to install the clamps around the head of the connection for a better grip

For vertical wall mounting, two Huliot Ultra Silent clamps should be assembled on every floor:

Fixed Clamp: The first of the two clamps should be installed at the lower third of the floor height of each floor, just below the pipe or fitting socket, and must be fully tightened.

Sliding Clamp: Should be mounted at the upper third of the floor height of each floor. The clamp should lightly press the pipe against the rubber rather than be closed tightly, to reduce the vibration intensity passed to the constructive elements.

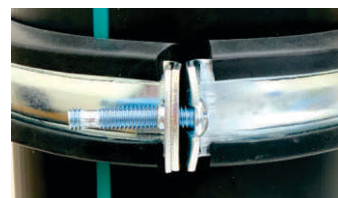
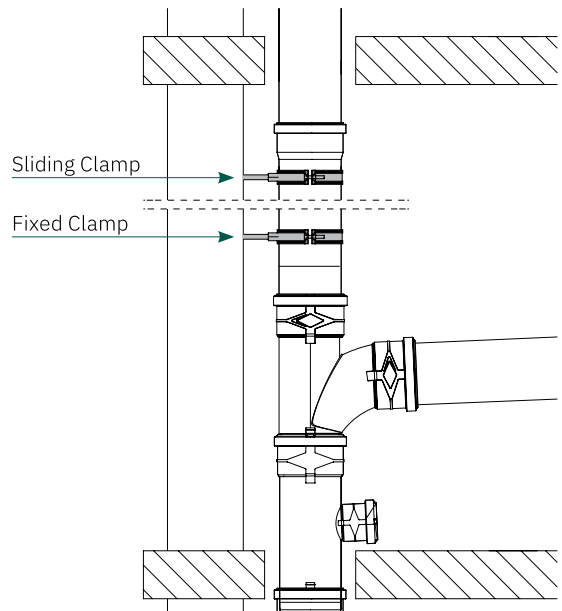

Lower Fixed clamp tightening level



Upper sliding clamp tightening level

PRESSURECLAMP™

Pressure Clamp connector for perfect ULTRA SILENT installation



Pressure resistance up to 4 BAR
Retrieval prevention

Pressure Clamp Applications

- Parking lot ceilings
- Exposed rainwater pipes
- Blind pipes for sewage drainage

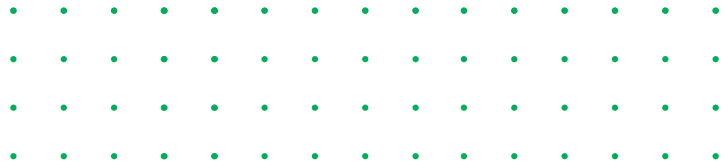

ENDLOCK™

Pressure end cap for sealing pipeline end

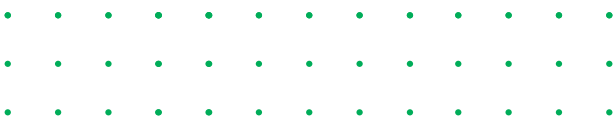

End Lock Assembly instructions

Connect the end cap to the pipe or fitting opening to be plugged

Ensure the presence of a gasket on the pipe or fitting to which the end cap is to be connected

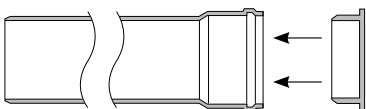

Connect the Endlock connector to the pipe or fitting end cap (Article 1)

Make sure the clips are in place and that the Endlock is properly aligned

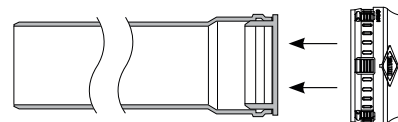

Tighten the metal band

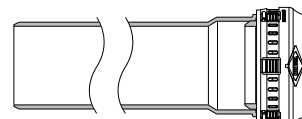

LOCKSEAL™

New upgraded and shortened Lock Seal, for easy and simple installation

Lock Seal Applications

When Installing pipes in concrete the use of Lock Seal:

Protects the push-fit connections against vibrations generated during concrete pouring

Protects the push-fit connections against lift forces generated during concrete drying

Prevents the concrete slurry from infiltrating to the gasket and interfering with proper sealing

Lock Seal Advantages

Easy and fast assembly

Increased safety

Tool-free installation

Lock Seal Assembly instructions

Lockseal is designed for use with PP pipes resilient to hydrostatic pressure and with annular strength suitable for concrete casting.



1

Assemble the narrow part of the Lock Seal socket to the extremity of the pipe or the socket



2

Insert the plain end of the fitting or pipe into the socket (normal push-fit connection method)



3

Slide down the Lock Seal until it is properly aligned and the clips settle down in the socket to complete the installation



To facilitate the assembly, it is recommended to use Huliots pipe lubricant.



For disassembly, open the clips to pull the Lock Seal off

ULTRASEAL™



Ultra Seal System

Ultraseal provides the ideal solution for preventing the structure-borne noise created between wastewater pipes and solid construction.

Ultraseal prevents moisture transition between floors at the pipe borehole.

Ultraseal integrates a thin, highly flexible, waterproof geotextile membrane for perfect adherence to sealants and bituminous cement.

Ultra Seal Advantages

Strong elastic gasket

Fast, simple assembly

No special tools or equipment required

Elastic, flexible, durable

Geotextile membrane meets European standards for wet rooms

Ultra Seal Assembly instructions



1

Assembled on the pipe and placed in the pipe borehole



3

Second insulating layer



2

Initial insulating layer (primer)



4

Final insulating layer



5

Filling and coating layer

Pipes

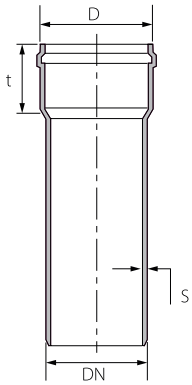

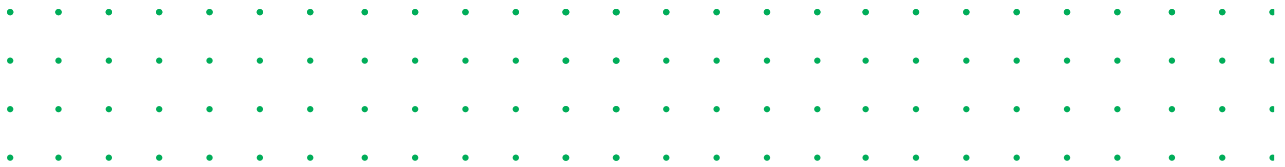

DN	D	S	t	S Class
32	45	1.8	42	S16
40	55	1.8	44	S16
50	65	1.8	46	S16
75	90	2.3	49	S16
90	107	2.8	54	S16
110	130	3.4	65	S16
125	149	3.9	72	S16
160	186	4.9	75	S16
200	228	6.2	108	S16



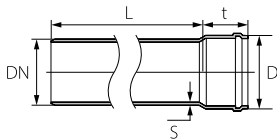

US Single Socket Pipe

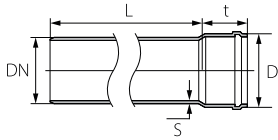

Code	DN	L	D	S	t		
5753200015	32	150	45	1.8	42	20	1440
5753200025	32	250	45	1.8	42	20	960
5753200050	32	500	45	1.8	42	20	480
5753200100	32	1000	45	1.8	42	15	300
5753200150	32	1500	45	1.8	42	15	300
5753200200	32	2000	45	1.8	42	15	300
5753200300	32	3000	45	1.8	42	15	300
5754000015	40	150	55	1.8	44	20	1440
5754000025	40	250	55	1.8	44	20	960
5754000050	40	500	55	1.8	44	20	480
5754000100	40	1000	55	1.8	44	15	420
5754000150	40	1500	55	1.8	44	15	420
5754000200	40	2000	55	1.8	44	15	420
5754000300	40	3000	55	1.8	44	15	420
5755000015	50	150	65	1.8	46	20	960
5755000025	50	250	65	1.8	46	20	540
5755000050	50	500	65	1.8	46	20	400
5755000100	50	1000	65	1.8	46	15	270
5755000150	50	1500	65	1.8	46	15	270
5755000200	50	2000	65	1.8	46	15	270
5755000300	50	3000	65	1.8	46	15	270

US Single Socket Pipe



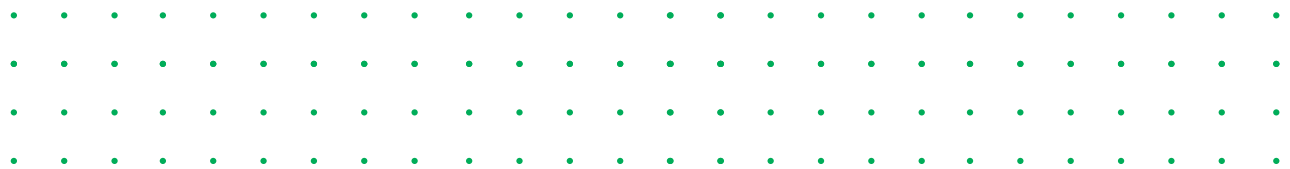

Code	DN	L	D	S	t		
5757500015	75	150	90	2.3	49	20	360
5757500025	75	250	90	2.3	49	20	240
5757500050	75	500	90	2.3	49	20	160
5757500100	75	1000	90	2.3	49	10	120
5757500150	75	1500	90	2.3	49	10	120
5757500200	75	2000	90	2.3	49	10	120
5757500300	75	3000	90	2.3	49	10	120
5759000015	90	150	107	2.8	54	20	240
5759000025	90	250	107	2.8	54	20	160
5759000050	90	500	107	2.8	54	10	120
5759000100	90	1000	107	2.8	54	10	100
5759000150	90	1500	107	2.8	54	10	100
5759000200	90	2000	107	2.8	54	10	100
5759000300	90	3000	107	2.8	54	10	100
5751100015	110	150	130	3.4	65	20	180
5751100025	110	250	130	3.4	65	20	180
5751100050	110	500	130	3.4	65	10	80
5751100100	110	1000	130	3.4	65	10	80
5751100150	110	1500	130	3.4	65	10	80
5751100200	110	2000	130	3.4	65	10	80
5751100300	110	3000	130	3.4	65	10	80
5751200015	125	150	149	3.9	72	10	120
5751200025	125	250	149	3.9	72	6	108
5751200050	125	500	149	3.9	72	6	72
5751200100	125	1000	149	3.9	72	8	80
5751200150	125	1500	149	3.9	72	8	80
5751200200	125	2000	149	3.9	72	8	80
5751200300	125	3000	149	3.9	72	8	80
5751600015	160	150	186	4.9	75	8	96
5751600025	160	250	186	4.9	75	8	48
5751600050	160	500	186	4.9	75	8	32
5751600100	160	1000	186	4.9	75	6	24
5751600150	160	1500	186	4.9	75	6	24
5751600200	160	2000	186	4.9	75	6	24
5751600300	160	3000	186	4.9	75	6	24
5752000100	200	1000	228	6.2	108	1	16
5752000300	200	3000	228	6.2	108	1	16

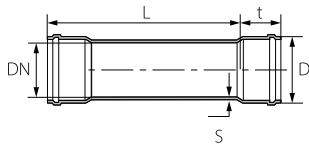

US Double Socket Pipe



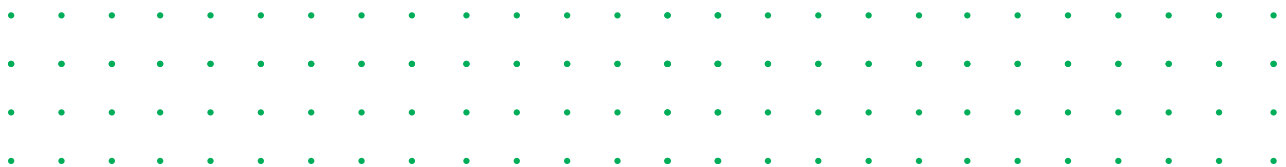

Code	DN	L	D	S	t		
5753232050	32	500	45	1.8	42	20	240
5753232100	32	1000	45	1.8	42	15	300
5753232150	32	1500	45	1.8	42	15	300
5753232200	32	2000	45	1.8	42	15	300
5753232300	32	3000	45	1.8	42	15	300
5754040050	40	500	55	1.8	44	20	240
5754040100	40	1000	55	1.8	44	15	420
5754040150	40	1500	55	1.8	44	15	420
5754040200	40	2000	55	1.8	44	15	420
5754040300	40	3000	55	1.8	44	15	420
5755050050	50	500	65	1.8	46	20	240
5755050100	50	1000	65	1.8	46	15	270
5755050150	50	1500	65	1.8	46	15	270
5755050200	50	2000	65	1.8	46	15	270
5755050300	50	3000	65	1.8	46	15	270
5757575050	75	500	90	2.2	49	20	120
5757575100	75	1000	90	2.2	49	10	120
5757575150	75	1500	90	2.2	49	10	120
5757575200	75	2000	90	2.2	49	10	120
5757575300	75	3000	90	2.2	49	10	120
5759090050	90	500	107	2.8	54	10	90
5759090100	90	1000	107	2.8	54	10	100
5759090150	90	1500	107	2.8	54	10	100
5759090200	90	2000	107	2.8	54	10	100
5759090300	90	3000	107	2.8	54	10	100
5751111050	110	500	130	3.4	65	10	60
5751111100	110	1000	130	3.4	65	10	80
5751111150	110	1500	130	3.4	65	10	80
5751111200	110	2000	130	3.4	65	10	80
5751111300	110	3000	130	3.4	65	10	80
5751212050	125	500	149	3.9	72	6	54
5751212100	125	1000	149	3.9	72	8	80
5751212150	125	1500	149	3.9	72	8	80
5751212200	125	2000	149	3.9	72	8	80
5751212300	125	3000	149	3.9	72	8	80



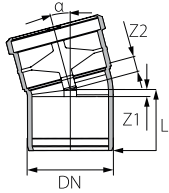

US Bend 15°



Code	DN	L	Z1	Z2		
7070000170	32	44.5	4	9.0	50	3000
7070010170	40	51.5	4	10.0	40	2400
7070020170	50	56.5	5	11.0	40	1200
7070030170	75	63.5	7	14.0	20	600
7070090170	90	68.0	8	16.0	20	480
7070040170	110	78.0	6	19.0	20	240
7070050170	125	87.0	12	21.9	10	160
7070060170	160	99.0	8	22.0	5	80

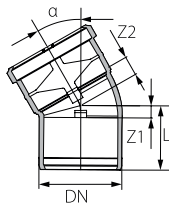

US Bend 30°



Code	DN	L	Z1	Z2		
7070000370	32	47.5	5	10.0	50	3000
7070010370	40	54.5	7	13.0	40	2400
7070020370	50	59.5	8	14.0	40	1200
7070030370	75	68.5	12	18.0	20	600
7070090370	90	74.0	14	20.5	20	320
7070040370	110	85.0	16	25.5	20	240
7070050370	125	104.0	29	30.0	10	160
7070060370	160	105.0	27	29.0	5	80

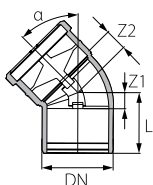

US Bend 45°



Code	DN	L	Z1	Z2		
7070000470	32	53.0	8	13.0	40	2400
7070010470	40	58.5	11	17.0	40	2400
7070020470	50	64.0	13	19.0	40	1200
7070030470	75	74.5	18	24.0	20	600
7070090470	90	81.0	21	27.5	20	320
7070040470	110	94.0	25	33.5	20	240
7070050470	125	104.0	29	38.0	10	120
7070060470	160	116.0	36	44.0	5	60
7070080470	200	148.0	49	63.0	3	36

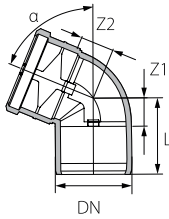

US Bend 67.5°

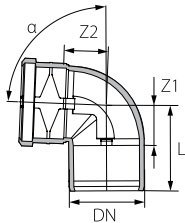

Code	DN	L	Z1	Z2		
7070000670	32	58.0	13	18	50	3000
7070010670	40	65.5	18	24	40	1600
7070020670	50	72.5	21	27	40	1200
7070030670	75	85.5	29	35	20	480
7070090670	90	94.0	34	40	20	320
7070040670	110	110.0	44	48	20	240

US Bend 87.5°



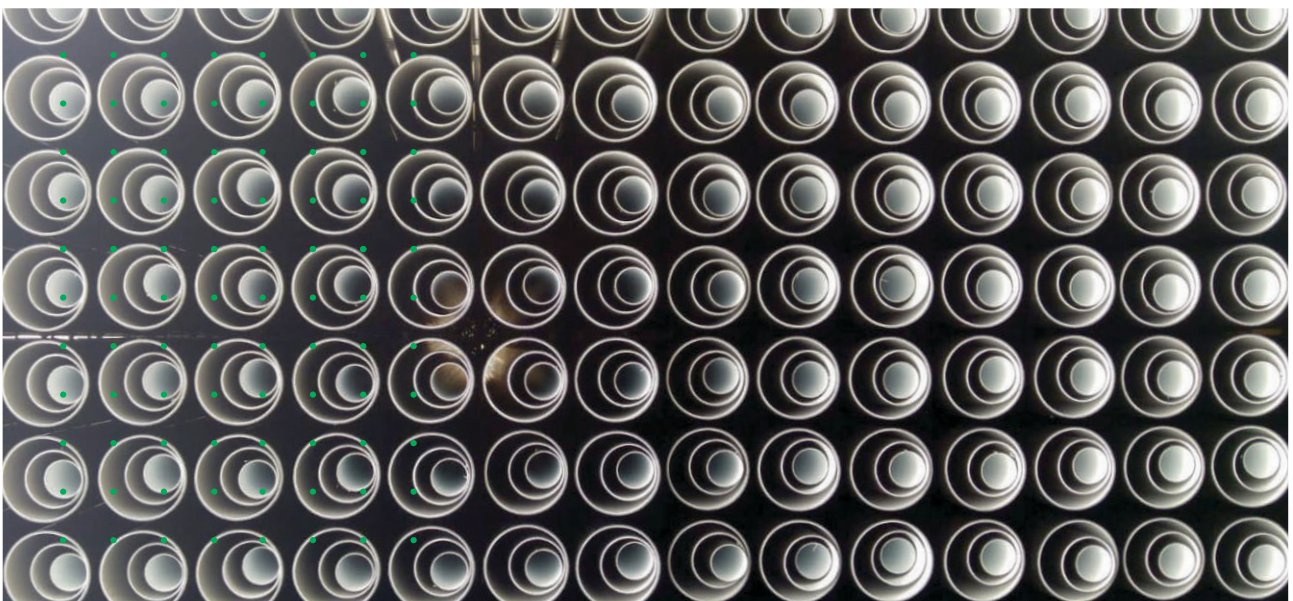

Code	DN	L	Z1	Z2		
7070000870	32	64.0	20.0	24	40	2400
7070010870	40	73.5	26.0	32	40	1600
7070020870	50	79.5	28.5	35	35	1050
7070030870	75	99.5	43.0	49	20	480
7070090870	90	110.0	50.0	56	20	320
7070040870	110	129.0	60.0	66	20	240
7070050870	125	142.0	67.0	73	10	120
7070060870	160	162.0	79.5	81	5	60



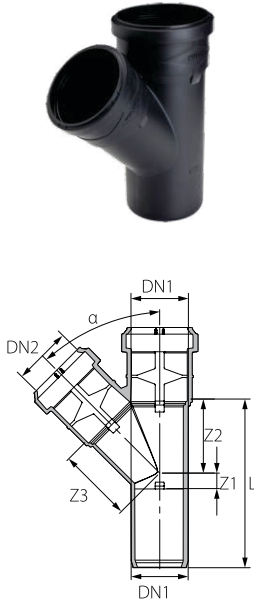

US Branch 45°



Code	DN1	DN2	Z1	Z2	Z3	L		
7070600470	32	32	9.0	42.0	42.0	95.0	30	1800
7070611470	40	40	11.0	52.0	52.0	111.0	20	800
7070621470	50	40	13.0	64.0	57.0	129.0	20	600
7070622470	50	50	13.0	64.0	64.0	129.0	20	600
7070632470	75	50	18.0	95.0	100.0	170.0	20	320
7070633470	75	75	18.0	95.0	95.0	170.0	20	320
7070691470	90	40	32.5	112.5	92.0	205.0	10	180
7070692470	90	50	32.5	112.5	89.0	205.0	10	180
7070699470	90	90	33.0	113.0	112.5	206.0	10	120
7070641470	110	40	17.0	112.0	96.5	148.5	10	160
7070642470	110	50	17.0	108.0	96.5	148.5	10	160
7070643470	110	75	2.0	121.0	113.5	184.5	10	120
7070649470	110	90	25.0	137.0	143.0	231.0	10	120
7070644470	110	110	25.0	137.0	137.0	231.0	8	96
7070654470	125	110	18.0	145.0	149.0	238.0	8	96
7070655470	125	125	31.0	152.0	152.0	258.0	6	72
7070664470	160	110	39.0	159.0	169.0	284.0	5	60
7070666470	160	160	39.0	194.0	194.0	319.0	3	36
7070686470	200	160	19.0	213.0	224.0	343.0	2	16
7070688470	200	200	25.0	219.0	226.0	399.0	4	16

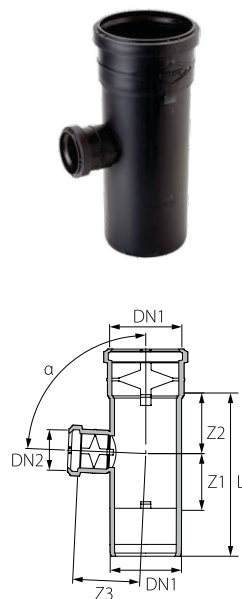

US Branch 87.5°



Code	DN1	DN2	Z1	Z2	Z3	L		
7070600870	32	32	9.0	42	40.0	94.0	20	1600
7070611870	40	40	13.0	64	64.0	64.5	20	1200
7070621870	50	40	32.3	31	62.0	112.5	20	600
7070622870	50	50	31.0	30	62.0	112.5	20	600
7070632870	75	50	58.0	55	60.0	170.0	20	320
7070633870	75	75	58.0	55	55.0	114.5	20	320
7070692870	90	50	69.0	76	83.0	205.0	10	180
7070642870	110	50	32.0	65	36.5	137.5	10	160
7070655870	125	125	78.0	73	72.0	225.0	6	72
7070666870	160	160	97.0	87	144.0	276.0	4	48

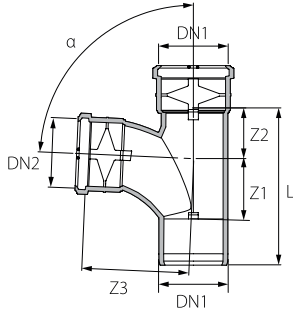

US Swept Branch 87.5°



Code	DN1	DN2	Z1	Z2	Z3	L		
7070799870	90	90	79	66	97	205	10	120
7070743870	110	75	82	60	97	211	10	120
7070749870	110	90	82	60	97	211	10	120
7070744870	110	110	82	60	97	211	10	120
7070754870	125	110	100	65	117	240	6	72
7070764870	160	110	96	84	117	266	4	48
7070744877	110	110	82	60	97	211	7	84

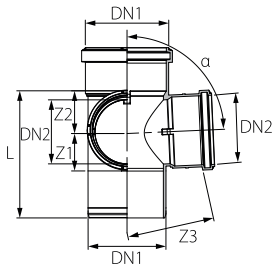

US Corner Branch 87.5°



Code	DN1	DN2	Z1	Z2	Z3	L		
7071244870	110	110	82	56	151	207	6	72
7071254870	125	110	58	75	140	207	5	60

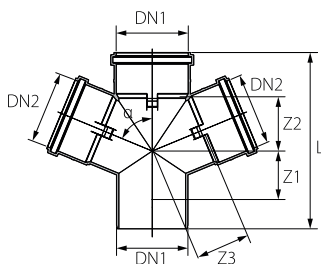

US Double Branch 67.5°



Code	DN1	DN2	Z1	Z2	Z3	L		
7071042670	110	50	17	54	73	207	9	108
7071044670	110	110	51	85	85	272	6	72

US Double Branch 87.5°



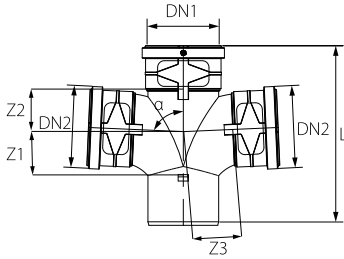

Code	DN1	DN2	Z1	Z2	Z3	L		
7071044870	110	110	82	56	151	207	6	72



US Inspection Pipe



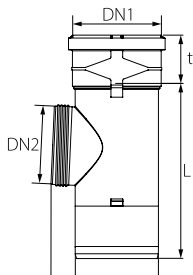

Code	DN1	DN2	t	L	L1		
7079120070	50	45.0	55	140	65.0	20	800
7079130070	75	45.0	71	140	98.0	25	400
7079190070	90	77.4	58	200	129.0	10	180
7079140070	110	97.0	64	231	140.0	10	120
7079150070	125	97.0	73	222	164.8	8	96
7079160070	160	97.0	85	236	198.4	6	72
7079180070	200	97.0	93	343	231.0	2	24



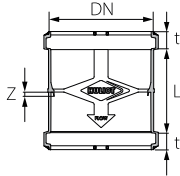

US Double Socket



Code	DN	t	L	Z		
7071700270	32	14.3	56.6	2.0	50	4000
7071710270	40	14.0	60.0	2.0	40	2400
7071720275	50	16.0	64.0	4.0	20	1200
7071730275	75	16.4	73.0	6.0	20	800
7071790270	90	14.0	85.0	1.4	20	480
7071740275	110	17.0	97.0	9.0	20	320
7071750275	125	17.0	118.6	10.4	10	160
7071760275	160	23.0	119.0	10.6	12	144
7071780275	200	28.5	135.0	12.0	2	48

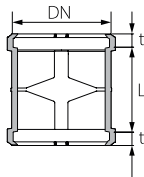

US Sleeve



Code	DN	t	L		
7071700070	32	14.3	56.6	50	4000
7071710070	40	14.0	60.0	30	1800
7071720070	50	14.0	68.0	20	1200
7071730070	75	14.0	77.0	20	800
7071790070	90	14.0	85.0	20	480
7071740070	110	17.0	97.0	20	320
7071750070	125	16.8	118.6	10	160
7071760070	160	17.0	131.0	12	144
7071780070	200	28.3	192.2	2	48

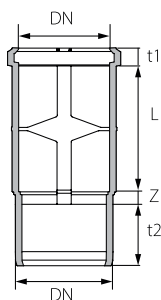

US Long Socket



Code	DN	t1	t2	L	Z		
7072210070	40	14.1	47.55	81.26	4.74	30	1800
7072220070	50	14.1	51.55	101.00	6.74	20	800
7072230070	75	14.1	56.58	114.97	9.45	20	360
7072290070	90	14.1	60.00	133.90	13.10	20	320
7072240070	110	16.6	69.41	144.46	14.12	15	180
7072250070	125	19.1	75.00	188.94	15.63	12	144
7072260070	160	23.1	86.00	204.81	20.60	6	72

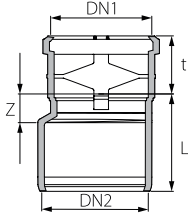

US Reducer



Code	DN1	DN2	L	t	Z		
7072110070	32	40	48.0	42.0	14	30	1800
7072120070	32	50	65.0	42.0	15	30	1800
7072121070	40	50	64.0	42.0	15	30	1800
7072191070	40	90	93.0	47.0	35	32	960
7072141070	40	110	122.5	43.0	51	20	480
7072132070	50	75	85.0	47.0	26	20	1200
7072192070	50	90	97.0	47.0	34	20	800
7072142070	50	110	118.0	47.0	46	20	480
7072193070	75	90	86.0	51.5	24	20	600
7072143070	75	110	106.0	52.0	34	20	360
7072149070	90	110	101.0	55.0	29	20	360
7072154070	110	125	106.0	64.0	29	10	240
7072164070	110	160	137.0	64.0	84	10	120
7072165070	125	160	140.0	55.0	74	16	192
7072186070	160	200	153.0	80.0	54	6	96

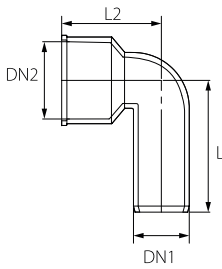

US Technical Bend / Siphon Connector



Code	DN1	DN2	L1	L2		
7074010970	32	46	76	58	40	2400
7074021970	40	50	82	56	20	1200
7074011970	40	46	76	56	20	1200
7074022970	50	50	82	60	20	1200



US Vent Cowl



Code	DN1		
42320040	50	-	240
42330040	75	-	96
42340060	110	-	80
42360040	160	-	27

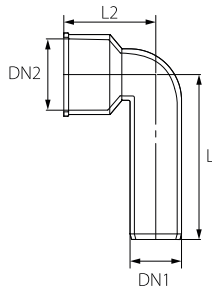

US Long Technical Bend / Siphon Connector



Code	DN1	DN2	L1	L2		
7074021971	40	50	140	56	20	1200
7074011971	40	46	140	57	20	1200

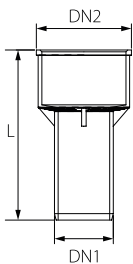

US Straight Fitting / Siphon Connector



Code	DN1	DN2	L		
7141760070	32	46	93	40	2400
7141761070	40	46	93	40	2400
7141721070	40	50	93	40	2400



Rubber Gasket for US, USSW, USSWL



Code	DN	DN2		
T047T000000000	26/32	46	500	-
T046T000000000	40	46	1000	-
T050T000000032	26/32	50	500	-
T050T000000040	40	50	500	-

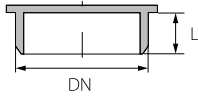

US End Cap

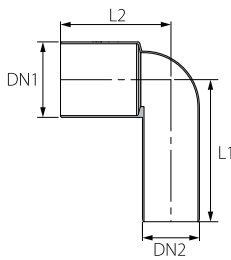

Code	DN	L		
7071610070	40	44	80	4800
7071620070	50	46	70	4200
7071630070	75	44	30	1800
7071690070	90	59	20	1200
7071640070	110	49	20	800
7071650070	125	75	20	480
7071660070	160	83	20	240
7071680070	200	65	10	180

US Long WC Bend



Code	DN1	DN2	L1	L2		
7195000070	119.6	90	175	225	10	120
7155000070	119.6	110	185	226	10	120

US Haff Stack x1 x2 x3 x4 x5 x6

Code	D	DN	D1/D2/D3	D4/D5/D6	L	L1	L2	L3	L4	H	H1	H2	H3
Haff Stack x1 x2 x3 x4 x5 x6	90	100	110	75	276	90	130	55	180	743	246	169	328

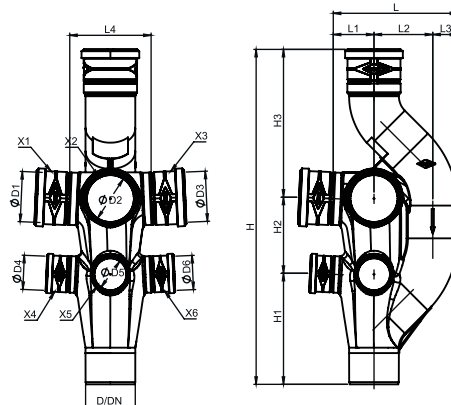

P - Trap With Risers

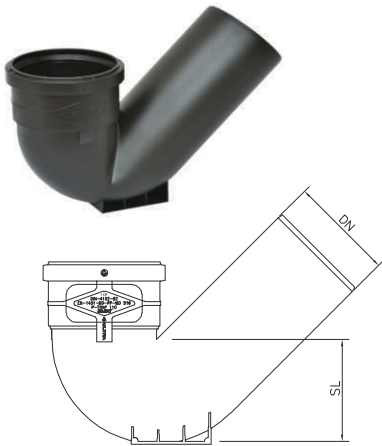

Code	Item Description	DN1	SL
49540750	P Trap	110	107
7071042877	DB Hopper	110x50x50	-
7071242877	Corner Hopper	110x50x50	-



Multi Trap With Risers And Gratings



Code	Item Description	DN1	SL	H
60117060	Multitrap	110	76	173
69201551	Height Riser	110	-	150
69203551	Height Riser	110	-	350

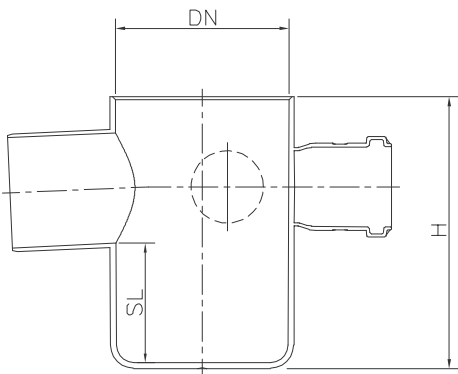

Nahani Trap With Gratings



Code	Item Description	DN1	DN2	H
69111750	Nahani Trap	110	75	88

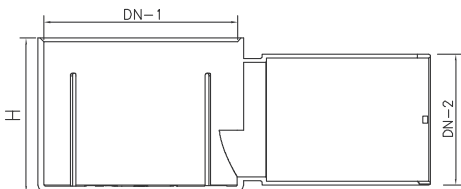

Accessories

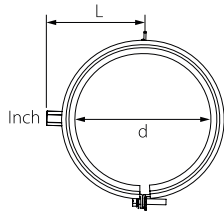

Acoustic Clamp



Art-Nr.	DN	M	Strip Size	Rubber Sleeve	Max Load (Kg)
7890004071	40	M8/M10	2x24	5 Ply EPDM	500
7890005071	50	M8/M10	2x24	5 Ply EPDM	500
7890007571	75	M8/M10	2x24	5 Ply EPDM	700
7890011071	110	M8/M10	2x24	5 Ply EPDM	700
7890012571	125	M8/M10	2x24	5 Ply EPDM	700
7890016071	160	M8/M10	2x24	5 Ply EPDM	700
7890020071	200	M8/M10	2x24	5 Ply EPDM	700

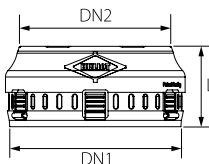

Lock Seal



Code	DN	DN1	DN2	L		
7072330000	75	91.5	79.8	59.0	48	1152
7072340000	110	130.0	112.0	63.0	30	480
7072350000	125	149.0	126.6	94.0	18	288
7072360000	160	186.5	162.0	99.7	10	240
7072380000	200	233.5	210.0	114.0	5	90

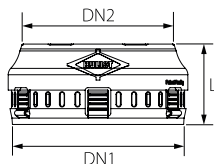
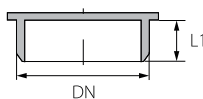

End Lock



Code	DN	DN1	DN2	L	L1		
7078004000	110	130.0	112.0	63.0	62	30	480
7078005000	125	149.0	126.6	94.0	75	12	192
7078006000	160	186.5	162.0	99.7	86	12	192
7078008000	200	233.5	210.0	114.0	57	4	40

Pressure Clamp



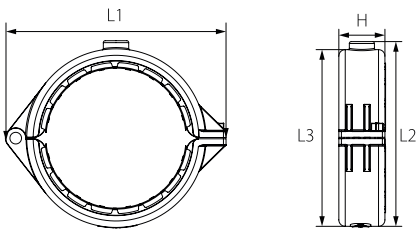

Code	DN	L1	L2	L3	H		
7073540070	110	170	144.28	138	36	20	800



Ultra Seal



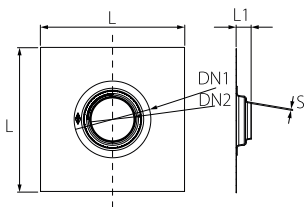

Code	DN	DN1	DN2	L	S	L1		
7981100000	110	220	102	340	3	52	30	480
7981250000	125	239	121	500	3	52	20	320
7981600000	160	266	149	500	3	52	20	320



Lubricant



Code	ml		
47700012	250	50	-
47700013	1000	12	1728





• • • • • • • • • •
• • • • • • • • • •
• • • • • • • • • •
• • • • • • • • • •
• • • • • • • • • •
• • • • • • • • • •
• • • • • • • • • •
• • • • • • • • • •
• • • • • • • • • •
• • • • • • • • • •

CLEARBLACK

The future is clear

Using MBR technology, ClearBlack's Sewage recycling system can treat sewage and reuse it for flushing, gardening, washing, and feeding for the RO process.

When used with a mobile application or web link in any browser, this system may show unit operation and performance in real-time using an Android or iOS SMARTPHONE and a REAL SMART operating system.

- High Effluent Quality
- Low Operation Cost
- Low Cost of Maintenance
- Totally Autonomous
- Modular & Flexible
- Total I.o.t Connectivity
- Completely Mobile (Containerized)

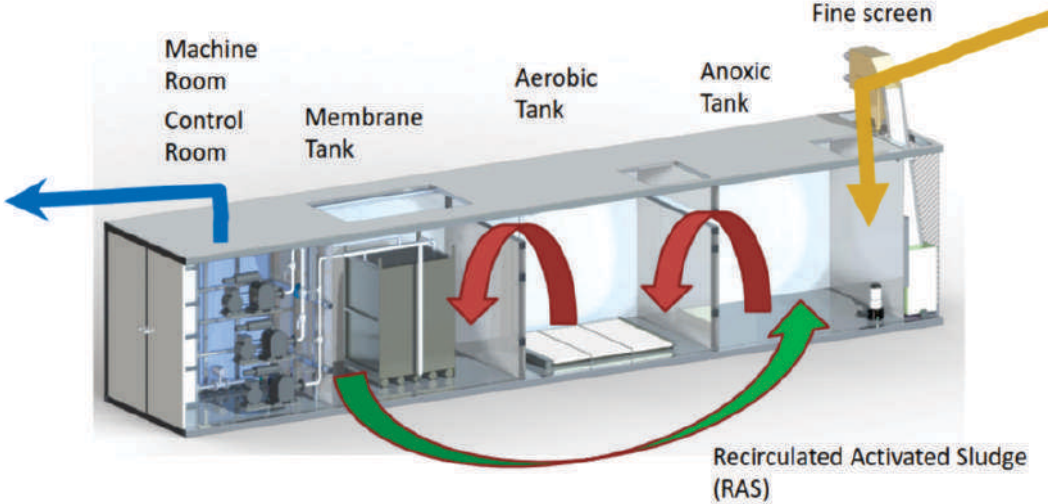

Scan for Catalogs



WE MAKE IT FLOW

Our Products



Domestic Drainage



Acoustic Drainage System



HT Drainage System



Induction Technology



Multilayer System



Clear Black



We Make it Flow

Huliot Group is a global leader in advanced flow systems for commercial and residential buildings, bringing complete solutions that cover water supply, wastewater, and infrastructure.

We design, manufacture and market a full range of products that work together in harmony, to deliver a seamless and silent water flow experience, while respecting the environment and keeping it clean.



PP-R



Fire Protection Networks



Manholes | Chambers



Channeling power cables in the building

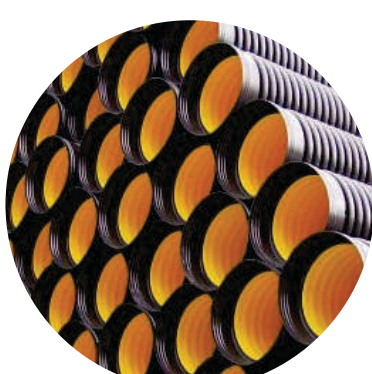

Running water, canalization and sewage



Geotechnical products

 **Huliot Group**

 **Huliot Israel**  **Huliot Slovenia**  **Huliot India**  **Huliot Heliroma**  **Huliot Hofit**  **Weisman Friedman**
by Huliot

714-715, Savli Industrial Estate, GIDC, Vadodara - 391 775. Gujarat, INDIA.
Tel: +91 265 2330671 | info@huliot.in

www.huliot.in